

Vinyl Post Installation Made Easy

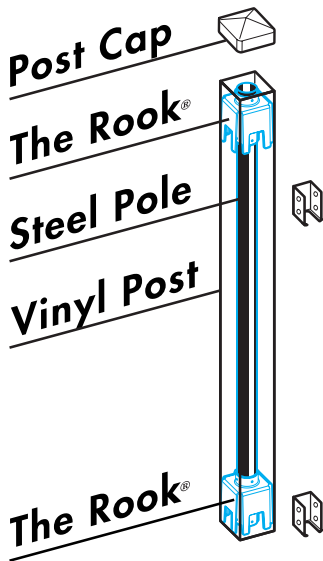

*Patented
The Rook[®]
Post Mount*

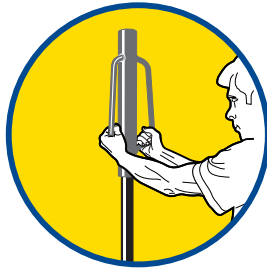

1
Drive the steel post using a post driver or sledge hammer. Our Earth Auger drill is recommended for drilling pilot holes into soil.

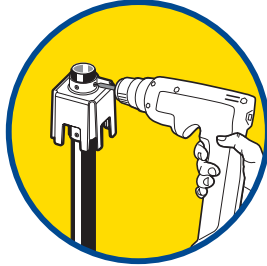

2
Attach "The Rooks[®]" using the screws provided.

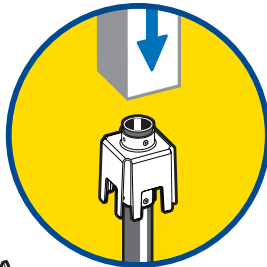

3
Slide the vinyl post over "The Rooks[®]" to complete the post installation.

Size:

*Four (4) sizes are available:
Fits 4" and 5" vinyl sleeves with and opening of 1-7/8" and 1-5/8" for round pipe.*

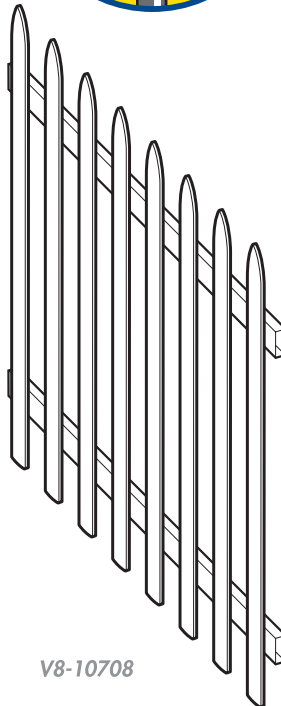



Vinyl Post Mount

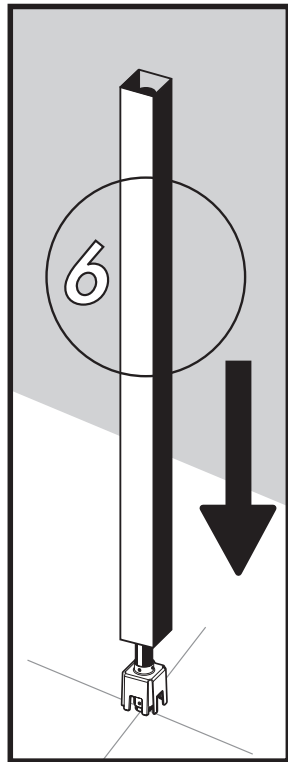
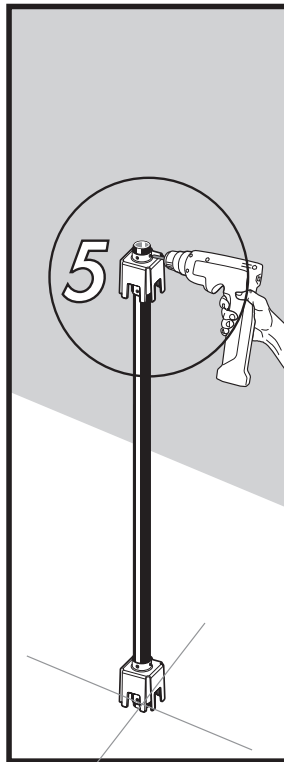
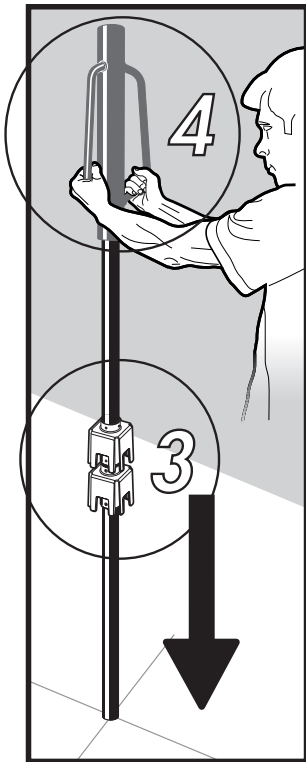
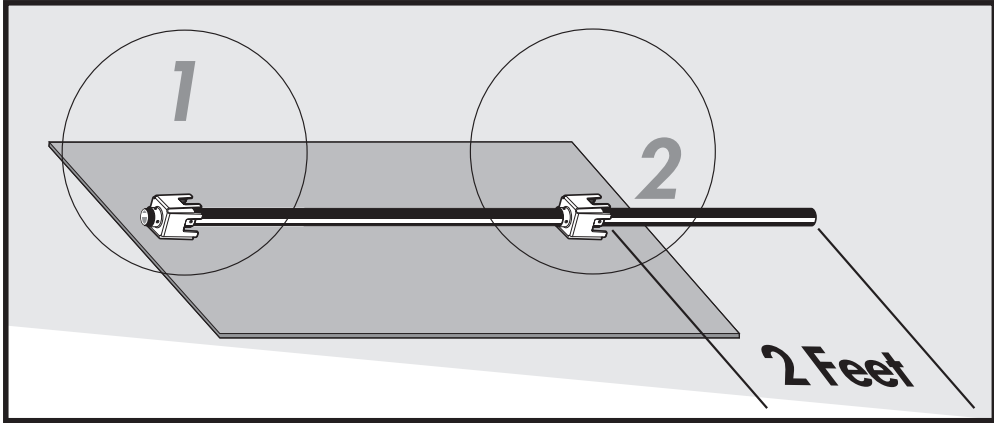

Instructions

- 1.** Lay the steel post down on a flat level surface and slide The Rooks into position. (Position the top Rook 2" down from the top of the pole. Position the bottom of the bottom Rook approximately 6" away from where the ground surface will be).
- 2.** Attach both Rooks to the pipe using the self-drilling screws provided. 4 screws per Rook is recommended. Extra downward force is required when driving screws.
- 3.** To avoid damage - Prior to driving the steel post into the ground remove the top Rook screws and allow it to slide down the pole and rest on the bottom Rook. The screw holes will act as pilot holes in Step 5 of the process.
- 4.** Drive the steel post into the ground using a post driver or sledge hammer. We recommend pre-drilling a pilot hole into the ground using our Earth Auger for this step.
- 5.** Re-attach the top Rook to the steel post using the pilot holes you created in step 2.
- 6.** Slide the vinyl post sleeve over The Rooks to complete the post installation.

Kit Includes:

- 2 - The Rook Post Mounts
- 8 - Self Drilling Hex Head Screws

Instrucciones

- 1.** Apoye el poste de acero sobre una superficie plana y nivelada y deslice los espaciadores Rook en posición. (Coloque el Rook superior 2" más abajo de la cima del poste. Posicione la parte de abajo del Rook inferior aproximadamente 6" de distancia de donde la superficie del suelo será).
- 2.** Adjuntar ambos Rooks a la tubería utilizando los tornillos auto-perforantes suministrados. Se recomienda utilizar 4 tornillos por Rook. Presión extra será necesaria al atornillar.
- 3.** Para evitar daños - Antes de colocar el poste de acero en el suelo, quite los tornillos del Rook superior y permita que éste se deslice hacia abajo del poste sobre el Rook inferior. Los agujeros de los tornillos actuarán como agujeros piloto en el paso 5 del proceso.
- 4.** Coloque el poste de acero en el suelo con un colocador de postes u otro método. Le recomendamos pre-perforar un agujero piloto en el suelo, utilizando para este paso, nuestro perforador de suelos.
- 5.** Vuelva a montar el Rook superior al poste de acero utilizando los agujeros piloto creados en el paso 2.
- 6.** Deslice los postes de vinilo sobre los Rooks para completar la instalación.

El Kit Incluye:

- 2 - Espaciadores Rook
- 8 - Tornillos hexagonales autoperforantes de 3/4"

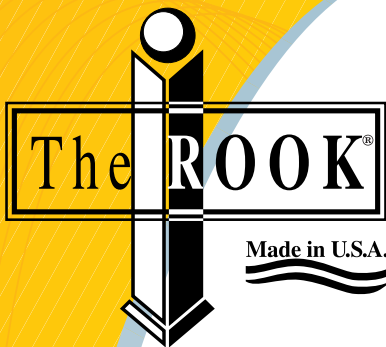

Vinyl Post Installation Made Easy

The Rook® post mounts are made of 100% PVC. They are designed as a spacer which is attached to a steel pipe and then secures a vinyl post. This creates a very solid and strong foundation for attaching a vinyl fence. They are ideally suited for soil and concrete applications.

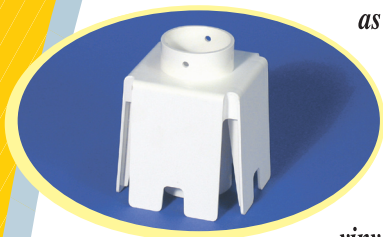

Applications

Do It Yourself Projects.
Ideal for Concrete Applications.
Retro Fit Over Existing Chain Link Fence.
Great For Large Contractor Projects.

Sizes

Four (4) sizes are available:
Fits 4" and 5" vinyl sleeves with and opening of 1-7/8" and 1-5/8" for round pipe.

Benefits

Easy to Install (Time and Cost Savings).
Strengthens the Entire Post Length, Not Just the Base.

Hole Digging Has Been Replaced by a Better Method, Installs in Minutes.

745 Fourth St.,
Somers Point, NJ 08244
800.568.0191
Fax: 609.487.0343
email: info@therook.org
www.therook.org